

SEAL CRAFT

Architectural Window Systems

DETAILS RECEPTOR PAN "A"

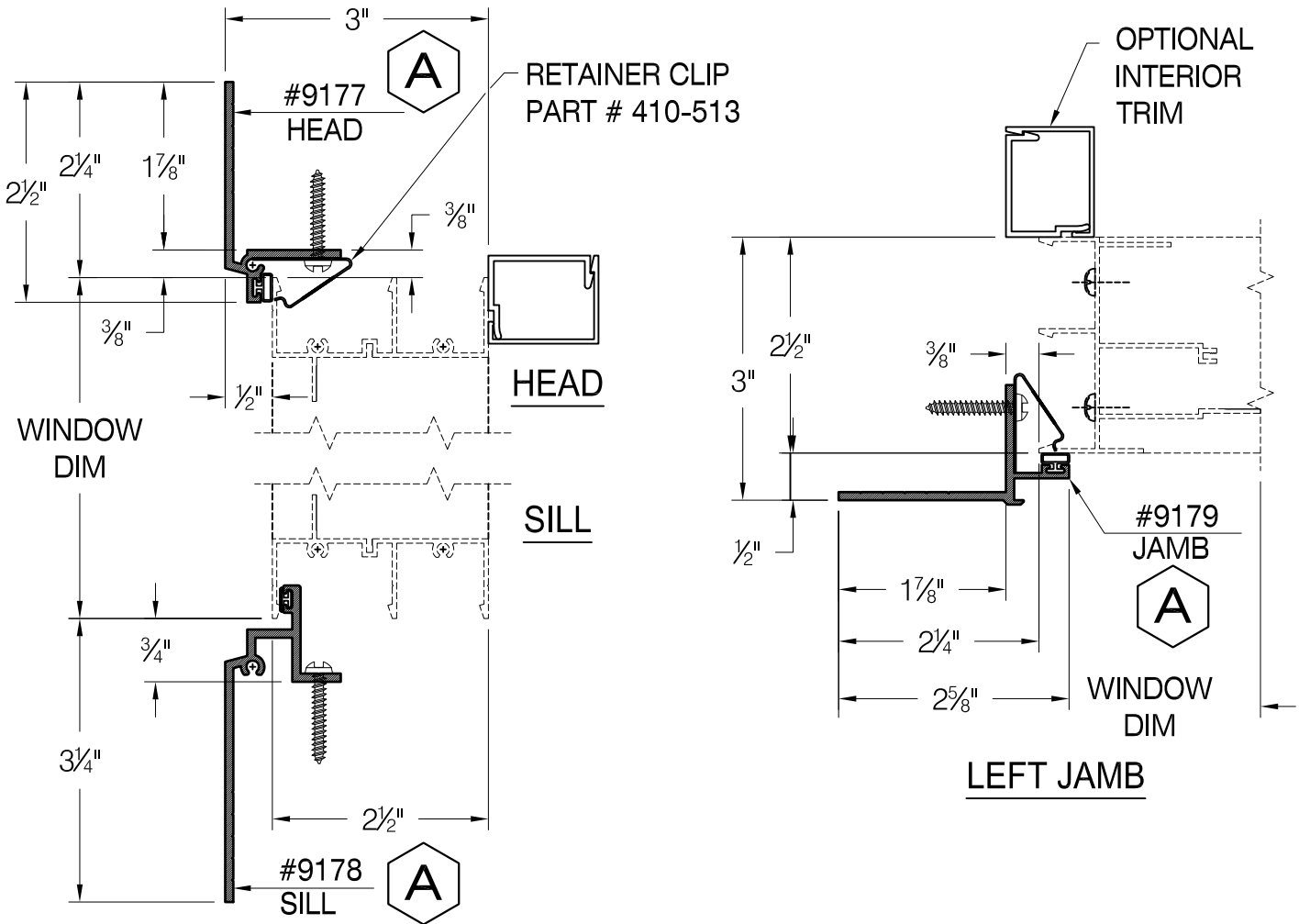

SEAL CRAFT

Architectural Window Systems

DETAILS RECEPTOR PAN "B"

B = "SELECTION GUIDE" CHOICE

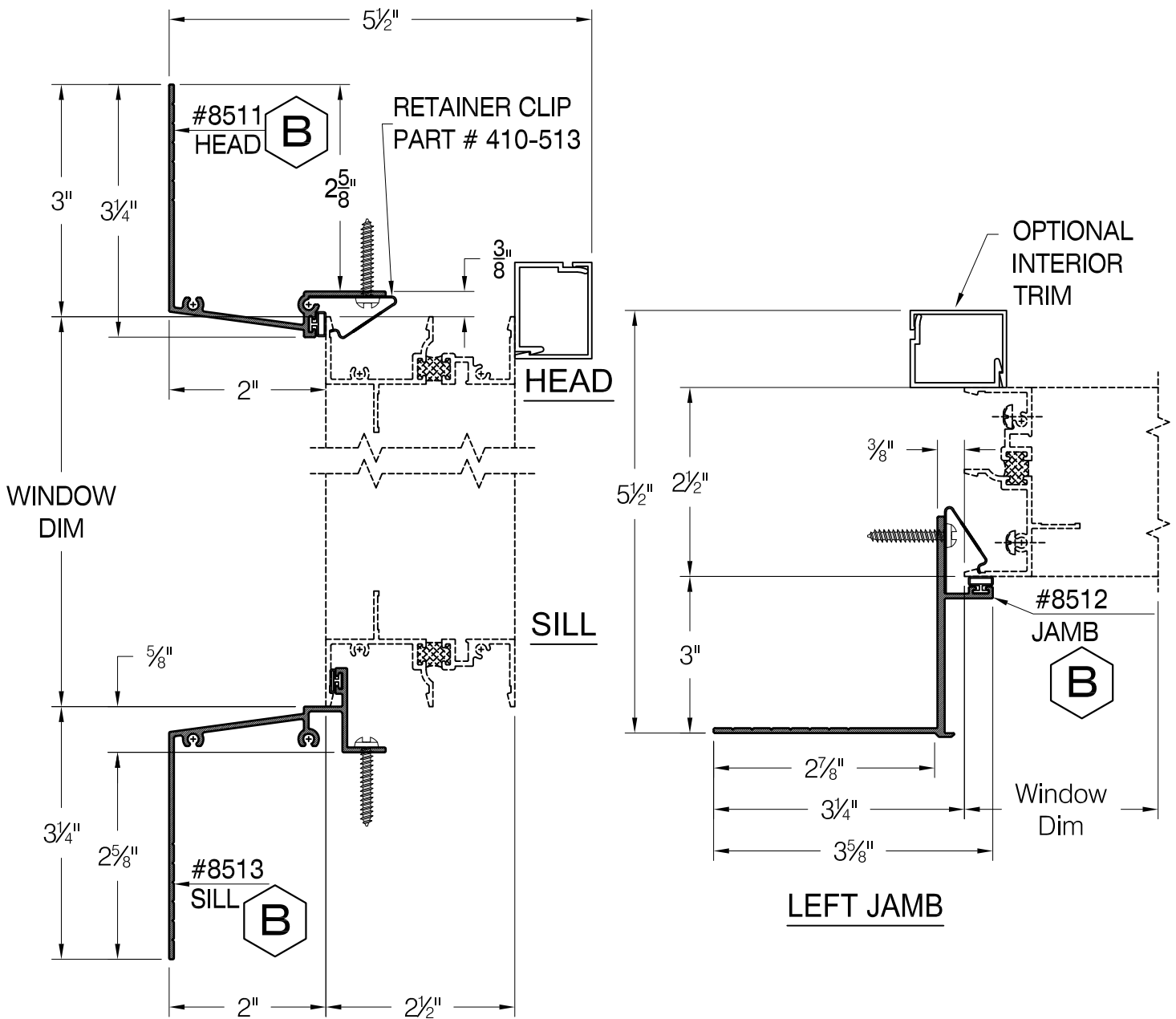

SEAL CRAFT

Architectural Window Systems

DETAILS RECEPTOR PAN "C"

C = "SELECTION GUIDE" CHOICE

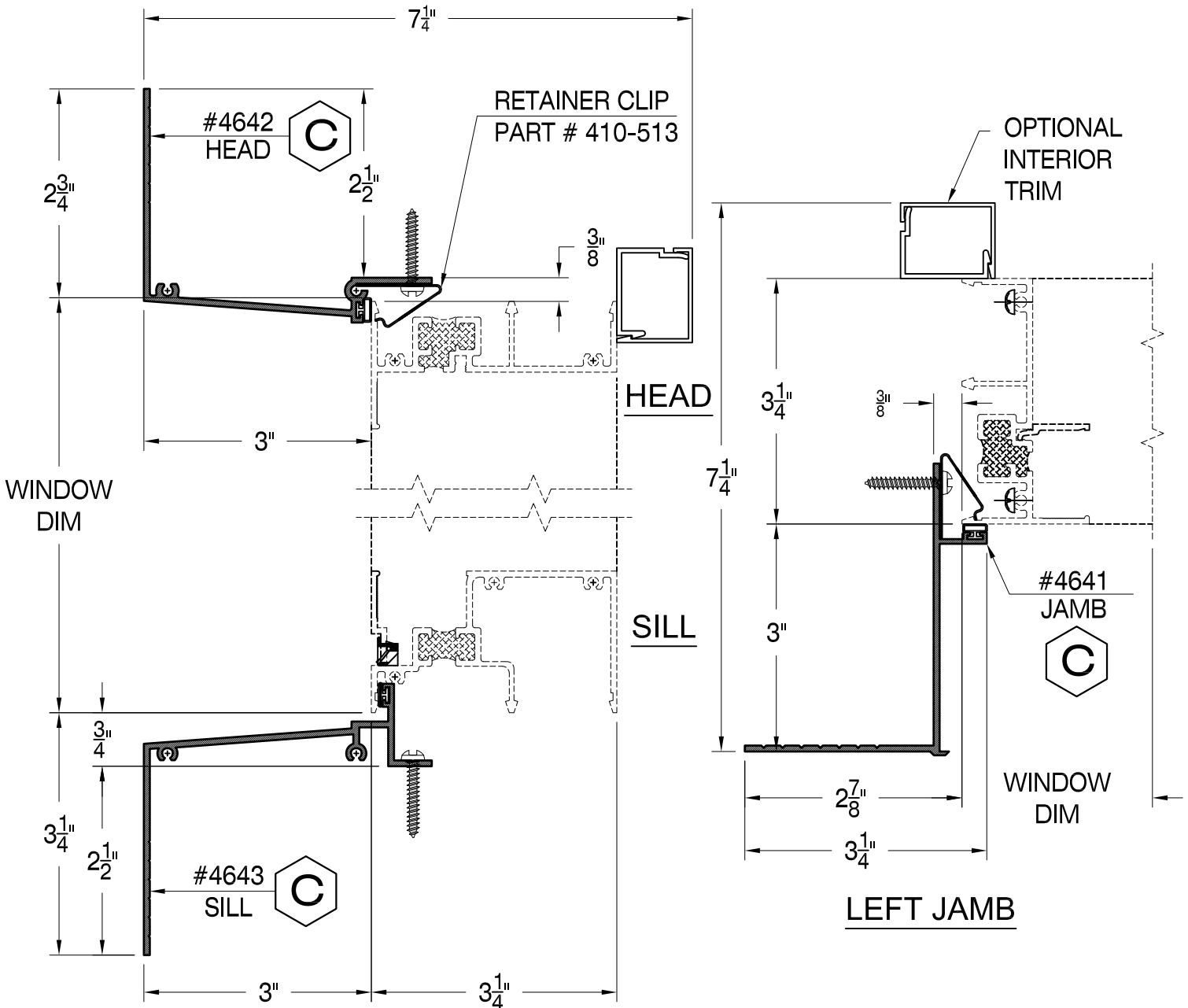

SEAL CRAFT

Architectural Window Systems

DETAILS RECEPTOR PAN "E"

E = "SELECTION GUIDE" CHOICE

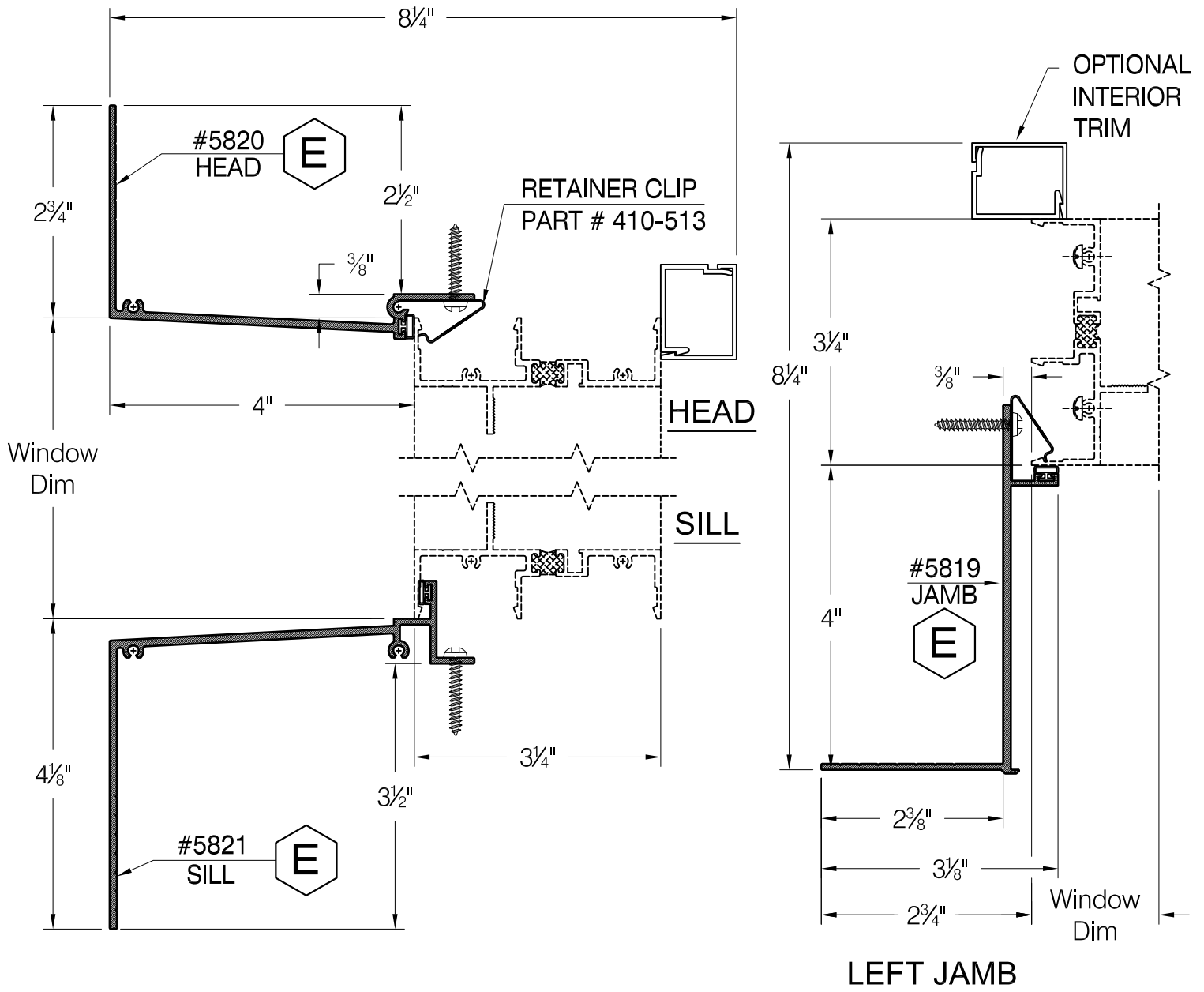

SEAL CRAFT

Architectural Window Systems

DETAILS RECEPTOR PAN "F"



= "SELECTION GUIDE" CHOICE

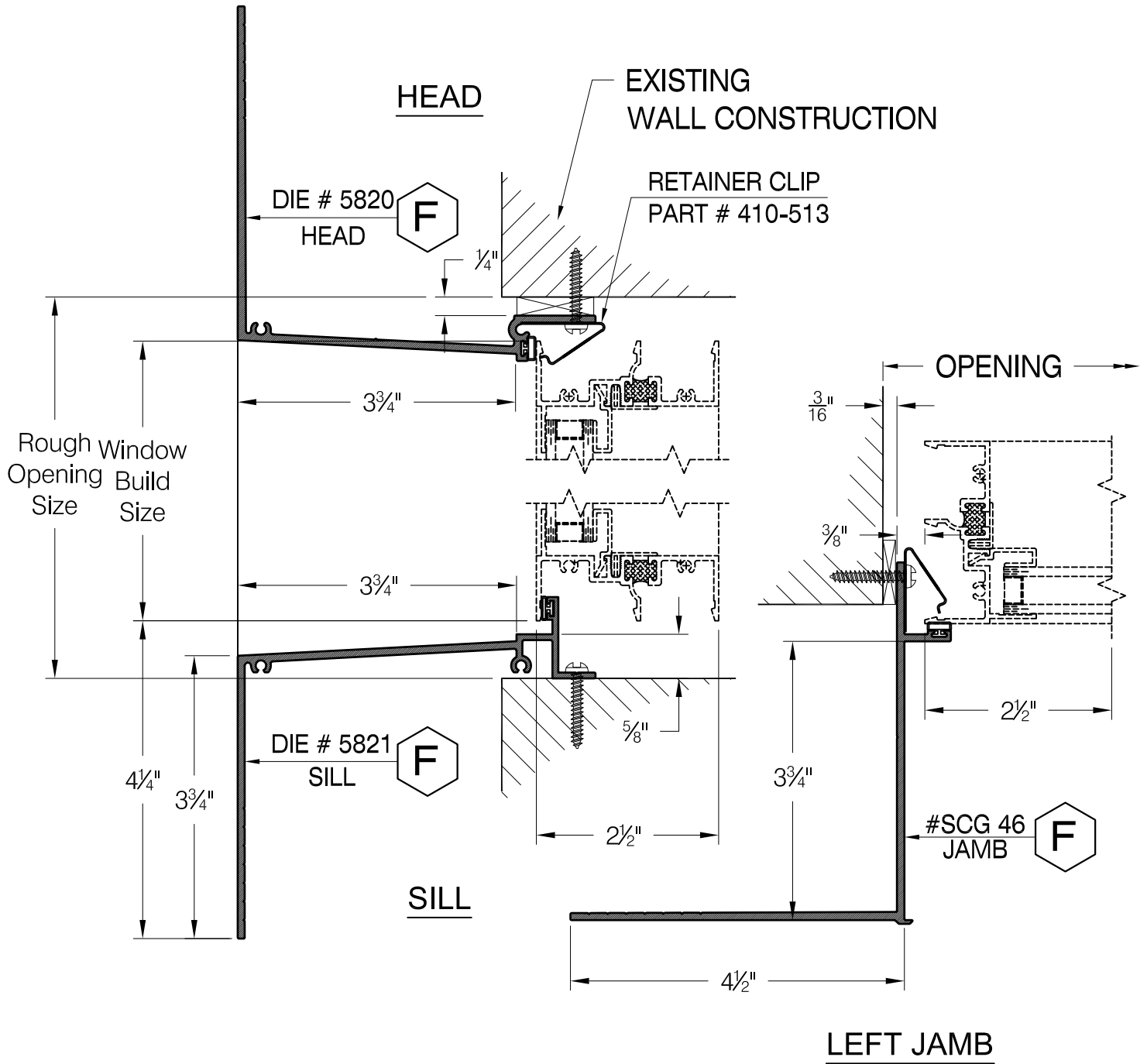

SEAL CRAFT

Architectural Window Systems

DETAILS MOUTON HISTORICAL PANNING

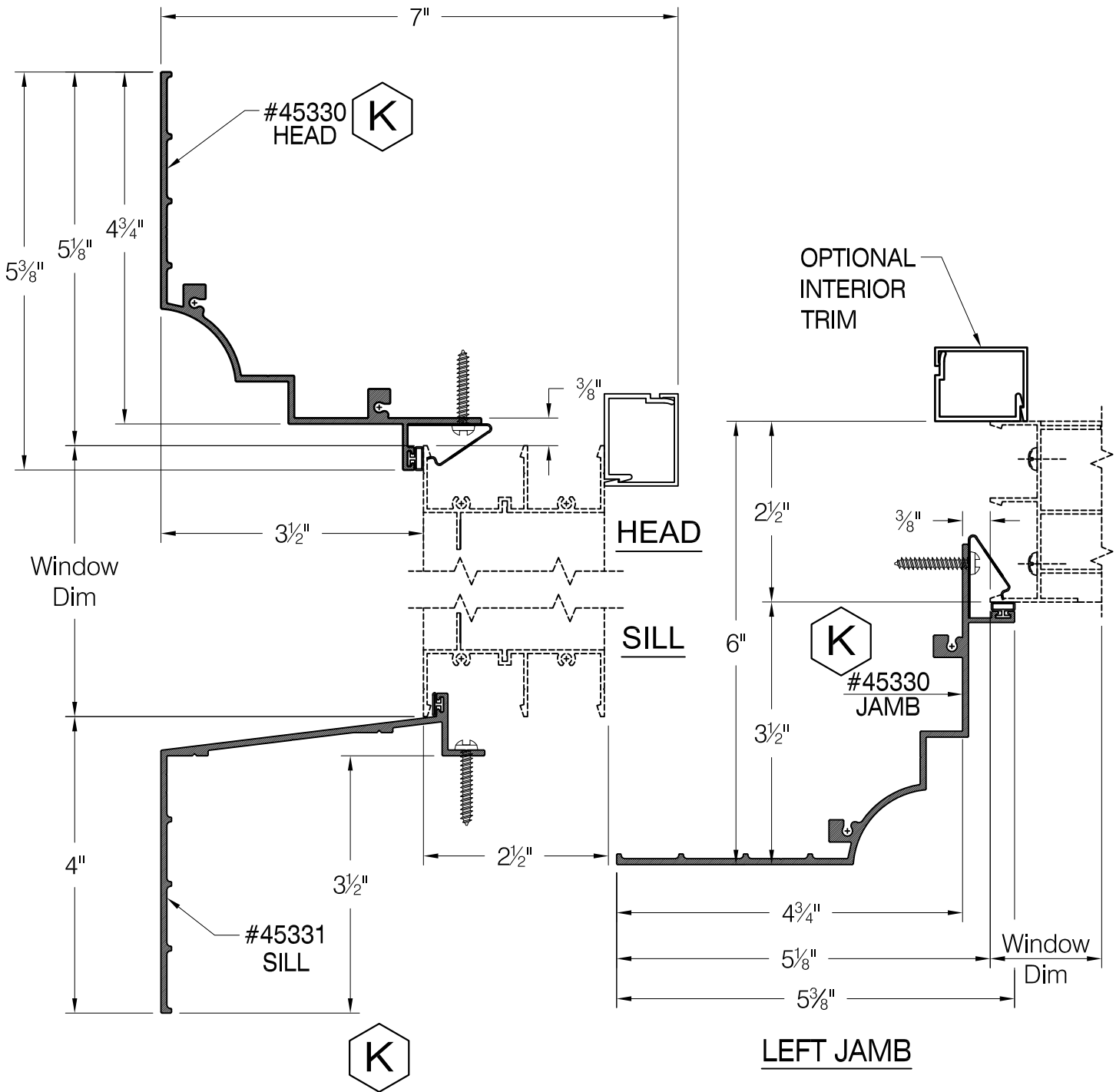

SEAL CRAFT

Architectural Window Systems

PANNING-MISCELLANEOUS

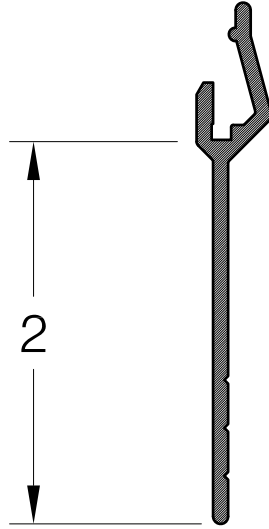

2" PAN EXTENDER
#4986

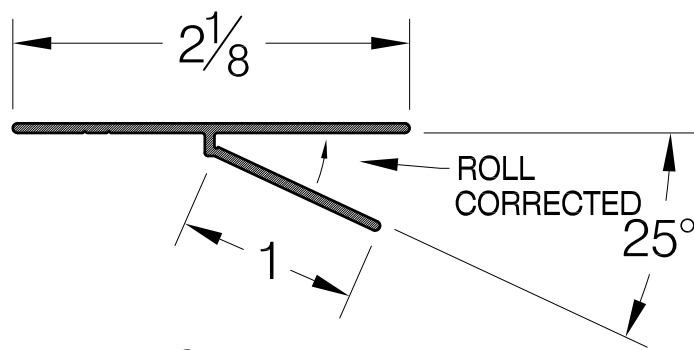

FLANGE EXTENDER
#5807